



BSS138

50V N-Channel Enhancement Mode MOSFET - ESD Protected

FEATURES

- $R_{DS(ON)}, V_{GS}@10V, I_{DS}@500mA=3\Omega$
- $R_{DS(ON)}, V_{GS}@4.5V, I_{DS}@200mA=4\Omega$
- $R_{DS(ON)}, V_{GS}@2.5V, I_{DS}@100mA=6\Omega$
- Advanced Trench Process Technology
- High Density Cell Design For Ultra Low On-Resistance
- Very Low Leakage Current In Off Condition
- Specially Designed for Battery Operated Systems, Solid-State Relays
Drivers : Relays, Displays, Lamps, Solenoids, Memories, etc.
- ESD Protected
- Lead free in comply with EU RoHS 2002/95/EC directives.
- Green molding compound as per IEC61249 Std. . (Halogen Free)

MECHANICAL DATA

- Case: SOT-23 Package
- Terminals : Solderable per MIL-STD-750, Method 2026
- Marking : 138
- Apprx. Weight: 0.0003 ounces, 0.0084 grams

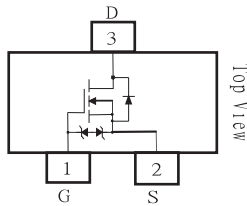

SOT-23

Unit : inch(mm)

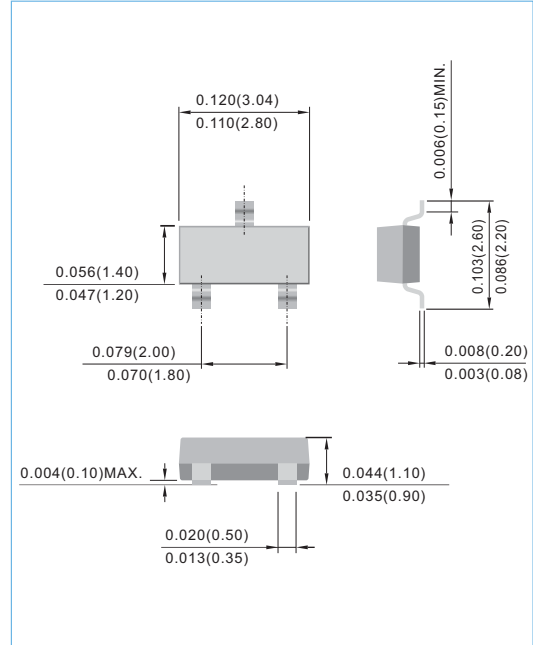

Maximum Ratings and Thermal Characteristics ($T_A=25^\circ\text{C}$ unless otherwise noted)

PARAMETER	Symbol	Limit	Units
Drain-Source Voltage	V_{DS}	50	V
Gate-Source Voltage	V_{GS}	± 20	V
Continuous Drain Current	I_D	300	mA
Pulsed Drain Current ¹⁾	I_{DM}	2000	mA
Maximum Power Dissipation	P_D	$T_A=25^\circ\text{C}$ 350 $T_A=75^\circ\text{C}$ 210	mW
Operating Junction and Storage Temperature Range	T_J, T_{STG}	-55 to + 150	$^\circ\text{C}$
Junction-to Ambient Thermal Resistance(PCB mounted) ²	$R_{\theta JA}$	357	$^\circ\text{C/W}$

- Note: 1. Maximum DC current limited by the package
2. Surface mounted on FR4 board, $t < 5$ sec

PAN JIT RESERVES THE RIGHT TO IMPROVE PRODUCT DESIGN,FUNCTIONS AND RELIABILITY WITHOUT NOTICE



BSS138

ELECTRICAL CHARACTERISTICS

Parameter	Symbol	Test Condition	Min.	Typ.	Max.	Units
Static						
Drain-Source Breakdown Voltage	BV_{DSS}	$V_{GS}=0V, I_D=10\mu A$	50	-	-	V
Gate Threshold Voltage	$V_{GS(th)}$	$V_{DS}=V_{GS}, I_D=250\mu A$	0.8	-	1.5	V
Drain-Source On-State Resistance	$R_{DS(on)}$	$V_{GS}=2.5V, I_D=100mA$	-	2.8	6.0	Ω
Drain-Source On-State Resistance	$R_{DS(on)}$	$V_{GS}=4.5V, I_D=200mA$	-	1.8	4.0	
Drain-Source On-State Resistance	$R_{DS(on)}$	$V_{GS}=10V, I_D=500mA$	-	1.6	3.0	
Zero Gate Voltage Drain Current	I_{DSS}	$V_{DS}=50V, V_{GS}=0V$	-	-	1	μA
Gate Body Leakage	I_{GSS}	$V_{GS}=\pm 20V, V_{DS}=0V$	-	-	±10	μA
Forward Transconductance	g_{fs}	$V_{DS}=10V, I_D=250mA$	100	-	-	mS
Dynamic						
Total Gate Charge	Q_g	$V_{DS}=25V, I_D=250mA$ $V_{GS}=4.5V$	-	-	1.0	nC
Turn-On Time	t_{on}	$V_{DD}=30V, R_L=100\Omega$ $I_D=300mA, V_{GEN}=10V$ $R_G=6\Omega$	-	-	40	ns
Turn-Off Time	t_{off}		-	-	150	
Input Capacitance	C_{iss}	$V_{DS}=25V, V_{GS}=0V$ $f=1.0MHz$	-	-	50	pF
Output Capacitance	C_{oss}		-	-	10	
Reverse Transfer Capacitance	C_{rss}		-	-	5	
Source-Drain Diode						
Diode Forward Voltage	V_{SD}	$I_S=250mA, V_{GS}=0V$	-	0.82	1.2	V
Continuous Diode Forward Current	I_S	-	-	-	300	mA
Pulse Diode Forward Current	I_{SM}	-	-	-	2000	mA

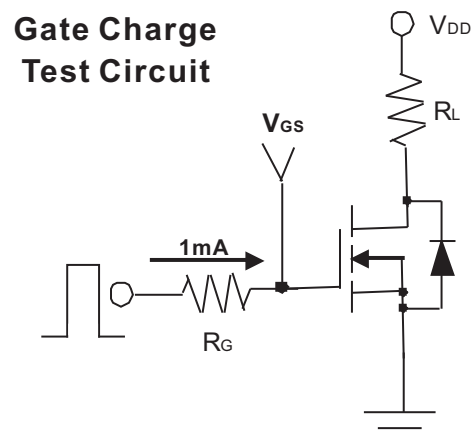
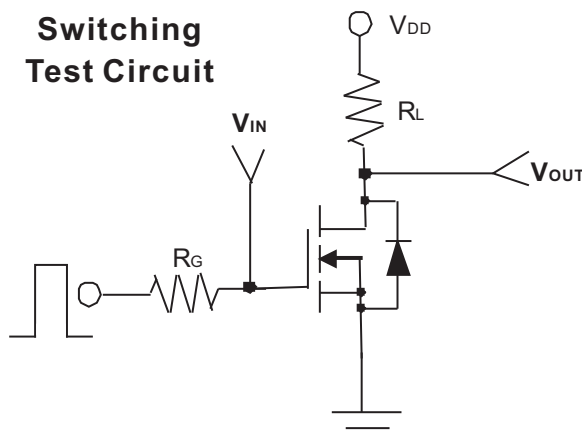



BSS138

Typical Characteristics Curves ($T_A=25^\circ\text{C}$, unless otherwise noted)

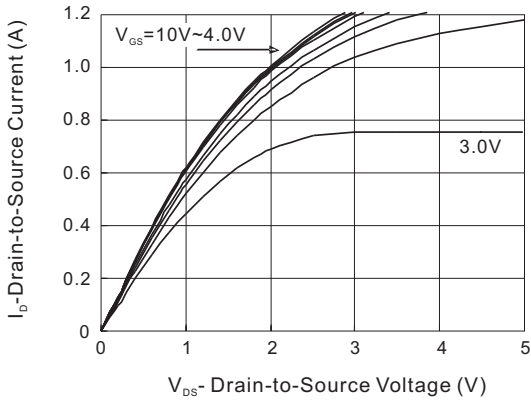

FIG.1- Output Characteristic

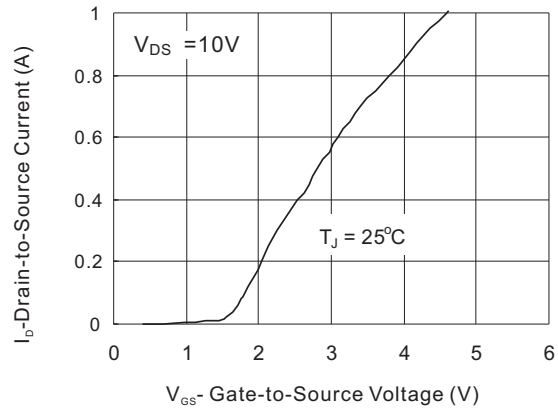

FIG.2- Transfer Characteristic

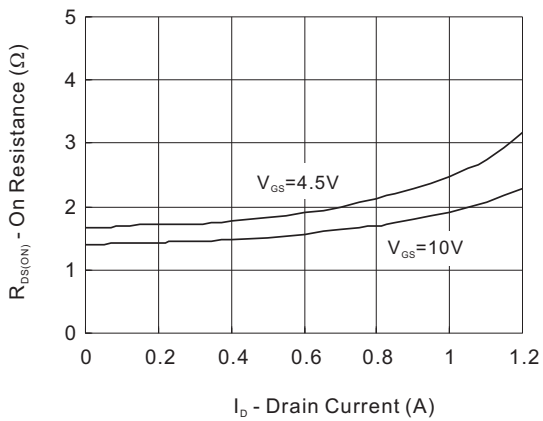

FIG.3- On Resistance vs Drain Current

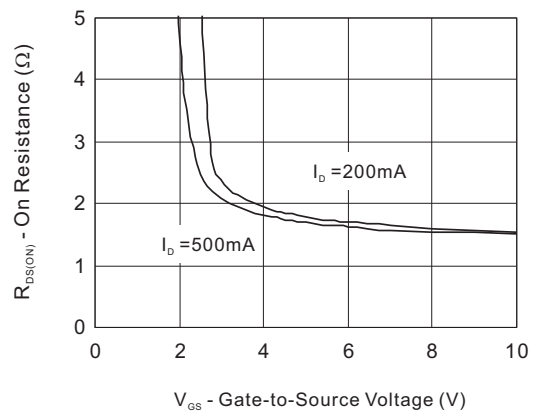

FIG.4- On Resistance vs Gate to Source Voltage

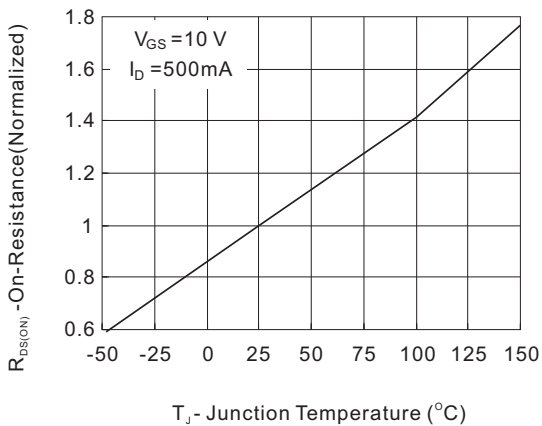

FIG.5- On Resistance vs Junction Temperature



BSS138

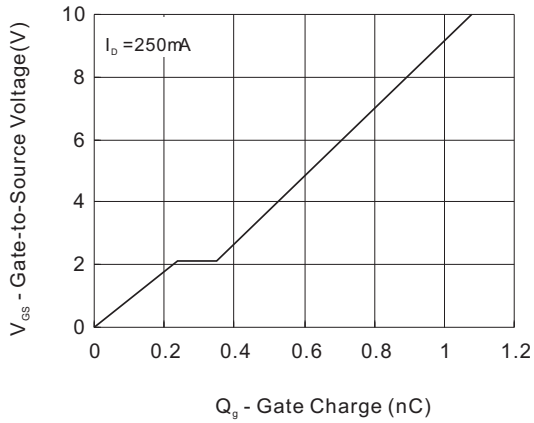

Fig.6 - Gate Charge Waveform

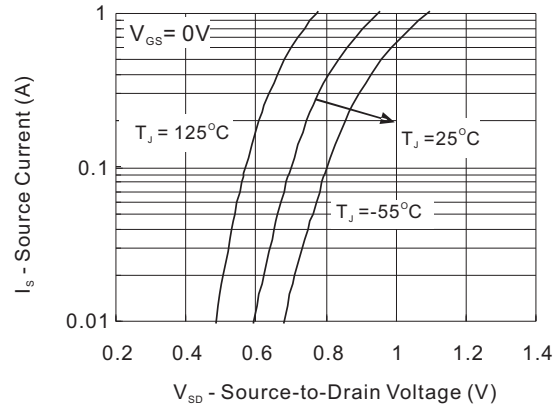

Fig.7 Source-Drain Diode Forward Voltage

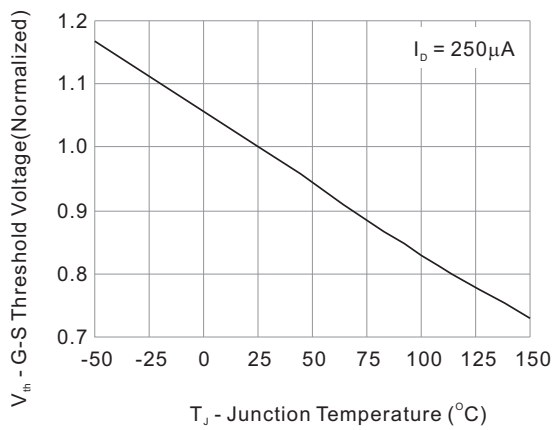

Fig.8 - Threshold Voltage vs Temperature

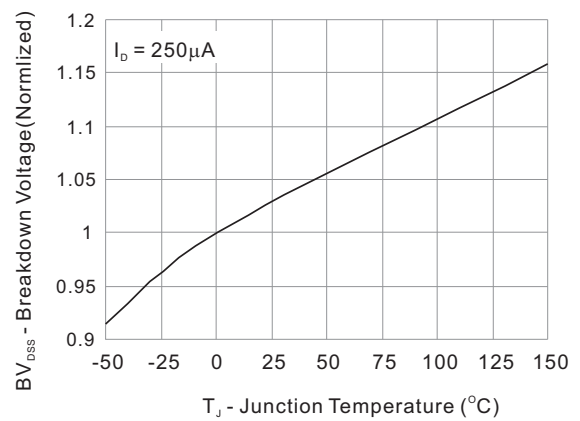

Fig.9 - Breakdown Voltage vs Junction Temperature



BSS138

MOUNTING PAD LAYOUT

SOT-23

Unit : inch(mm)

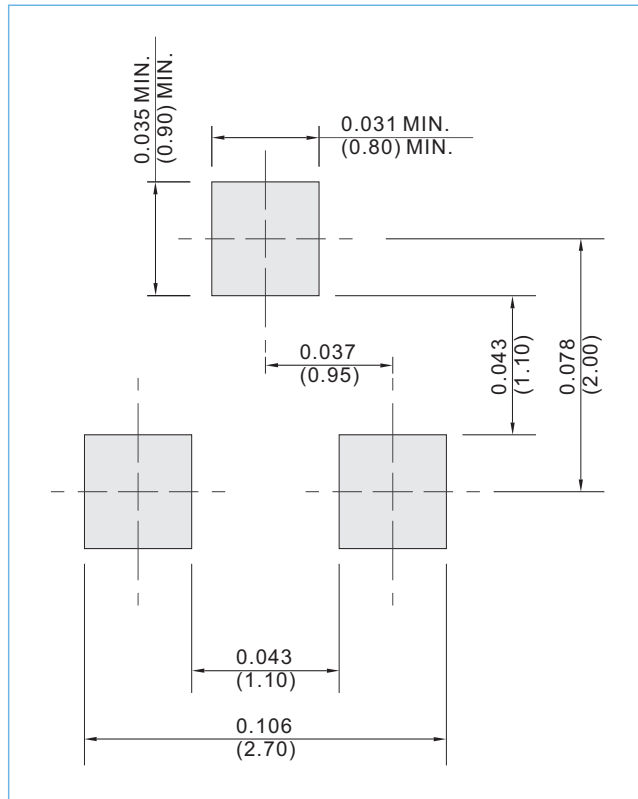

ORDER INFORMATION

- Packing information
T/R - 12K per 13" plastic Reel
T/R - 3K per 7" plastic Reel

LEGAL STATEMENT

Copyright PanJit International, Inc 2012

The information presented in this document is believed to be accurate and reliable. The specifications and information herein are subject to change without notice. Pan Jit makes no warranty, representation or guarantee regarding the suitability of its products for any particular purpose. Pan Jit products are not authorized for use in life support devices or systems. Pan Jit does not convey any license under its patent rights or rights of others.