

Two-channel switching regulator controller

BA9741F / BA9741FS

The BA9741F and BA9741FS are two-channel switching regulator controllers that use the PWM method. Both circuits can be used for DC to DC conversion for step-up, step-down, and inverting. The IC comes in a compact package, making it ideal for use in portable equipment.

●Applications

DC/DC converters for video cameras and notebook computers etc.

●Features

- 1) High-accuracy reference voltage circuit ($\pm 1\%$).
- 2) Timer-latch, short-circuit protection circuit
- 3) Miss-operation prevention circuit for low-voltage input.
- 4) Reference voltage with output (2.5V).
- 5) Rest period adjustment is possible over the entire duty range.

●Absolute maximum ratings (Ta = 25°C)

Parameter	Symbol	Limits	Unit	
Power supply voltage	V _{CC}	36	V	
Power dissipation	BA9741F	P _d	500*1	mW
	BA9741FS	P _d	650*1	mW
Operating temperature	T _{opr}	-40~+85	°C	
Storage temperature	T _{stg}	-55~+125	°C	
Output current	I _o	120*2	mA	
Output voltage	V _o	36	V	

*1 When mounted on 70mm×70mm ×1.6mm glass epoxy board.

Reduced by 5.0mW(BA9741F), 6.5mW(BA9741FS) for each increase in Ta of 1°C over 25°C.

*2 Should not exceed P_d and ASO values.

●Recommended operating conditions (Ta = 25°C)

Parameter	Symbol	Min.	Typ.	Max.	Unit
Power supply voltage	V _{CC}	3.6	6.0	35	V
Output current	I _o	—	—	100	mA
Output voltage	V _o	—	—	35	V
Error amplifier input voltage	V _{OM}	0.3	—	1.6	V
Timing capacitor	C _{CT}	100	—	15000	pF
Timing resistor	R _{RT}	5.1	—	50	kΩ
Oscillator frequency	F _{OSC}	10	—	800	kHz

● Block diagram

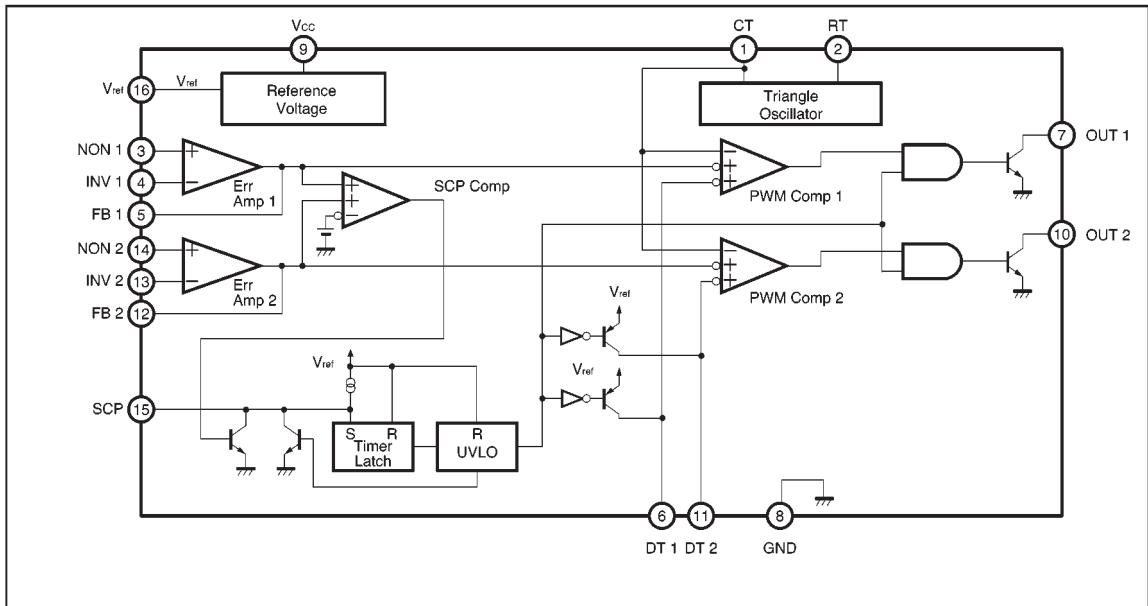

● Pin descriptions

Pin No.	Pin name	Function
1	CT	External timing capacitor
2	RT	External timing resistor
3	NON1	Positive input for error amplifier 1
4	INV1	Negative input for error amplifier 1
5	FB1	Error amplifier 1 output
6	DT1	Output 1 dead time / soft start setting
7	OUT1	Output 1
8	GND	Ground
9	Vcc	Power supply
10	OUT2	Output 2
11	DT2	Output 2 dead time / soft start setting
12	FB2	Error amplifier 2 output
13	INV2	Negative input for error amplifier 2
14	NON2	Positive input for error amplifier 2
15	SCP	Time latch setting
16	Vref	Reference voltage output (2.5V)

●Electrical characteristics (unless otherwise noted, Ta = 25°C, and Vcc = 6V)

Parameter	Symbol	Min.	Typ.	Max.	Unit	Coniditions
〈Reference voltage block〉						
Output voltage	V _{ref}	2.4	2.5	2.6	V	I _{ref} =1mA
Input stability	V _{DLI}	—	1	10	mV	V _{CC} =3.6~35V
Load stability	V _{BLO}	—	1	10	mV	I _{ref} =0~5mA
〈Triangular wave oscillator〉						
Oscillation frequency	F _{OSC}	320	400	480	kHz	R _{FT} =10kΩ, C _{CT} =220pF
Frequency deviation	F _{ΔV}	—	1	—	%	V _{CC} =3.6~35V
〈Protection circuit〉						
Threshold voltage	V _{IT}	1.48	1.64	1.80	V	—
Standby voltage	V _{STB}	—	50	100	mV	No pull up
Latch voltage	V _{LT}	—	30	100	mV	No pull up
Source current	I _{SCP}	1.5	2.5	3.5	μA	—
Comparator threshold voltage	V _{CT}	0.9	1.05	1.2	V	5pin, 12pin
〈Rest period adjustment circuit〉						
Input threshold voltage (f _{osc} = 10kHz)	V _{I0}	1.79	1.97	2.15	V	Duty cycle=0%
	V _{I100}	1.32	1.48	1.64	V	Duty cycle=100%
On duty cycle	D _{ON}	45	55	65	%	Divide V _{ref} usung 13kΩ and 27kΩ
Input bias current	I _{BDT}	—	0.1	1	μA	DT1, DT2=2.0V
Latch mode source current	I _{DT}	200	560	—	μA	DT1, DT2=0V
Latch input voltage	V _{DT}	2.28	2.48	—	V	I _{DT} =40 μA
〈Low-voltage input miss-operation prevention circuit〉						
Threshold voltage	V _{UT}	—	2.53	—	V	—
〈Error amplifier〉						
Input offset voltage	V _{IO}	—	—	6	mV	—
Input offset current	I _{IO}	—	—	30	nA	—
Input bias current	I _B	—	15	100	nA	—
Open circuit gain	AV	70	85	—	dB	—
Common-mode input voltage range	V _{OM}	0.3	—	1.6	V	V _{CC} =3.6~35V
Common-mode rejection ratio	CMRR	60	80	—	dB	—
Maximum output voltage	V _{OH}	2.3	2.5	—	V	—
Minimum input voltage	V _{OL}	—	0.7	0.9	V	—
Output sink current	I _{OI}	3	20	—	mA	FB=1.25V
Output source current	I _{OO}	45	75	—	μA	FB=1.25V
〈PWM comparator〉						
Input threshold voltage (f _{osc} = 10kHz)	V _{I0}	1.79	1.97	2.15	V	Duty cycle=0%
	V _{I100}	1.32	1.48	1.64	V	Duty cycle=100%

©Not designed for radiation resistance.

Parameter	Symbol	Min.	Typ.	Max.	Unit	Coniditions
〈Output block〉						
Saturation voltage	V_{SAT}	—	0.8	1.2	V	$I_o=75mA$
Leak current	I_{REAK}	—	0	5	μA	$V_o=35V$
〈Total device〉						
Standby current	I_{CCS}	—	1.3	1.8	mA	When output is off
Average current consumption	I_{CCA}	—	1.6	2.3	mA	$R_{RT}=10k\Omega$

©Not designed for radiation resistance.

●Timing chart

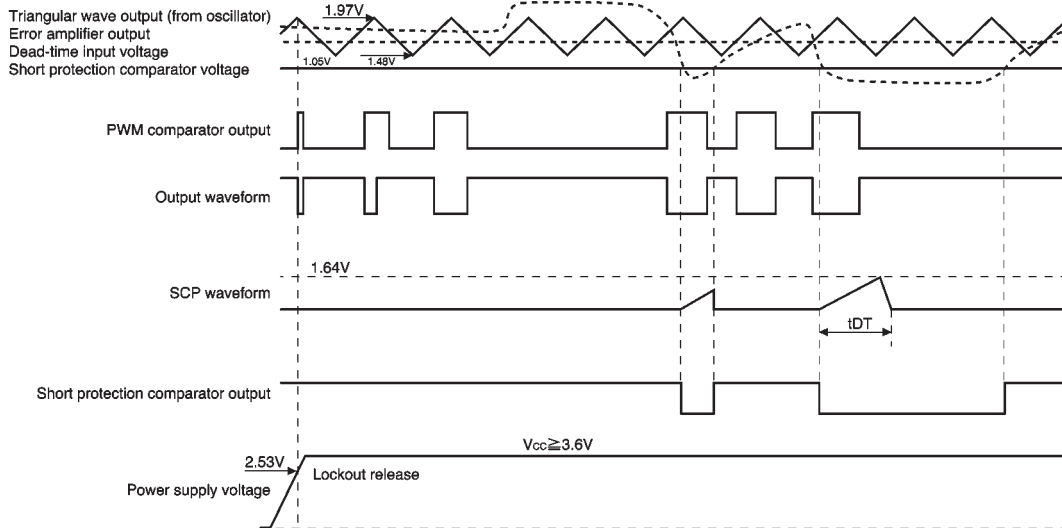

Fig.1

●Electrical characteristic curves

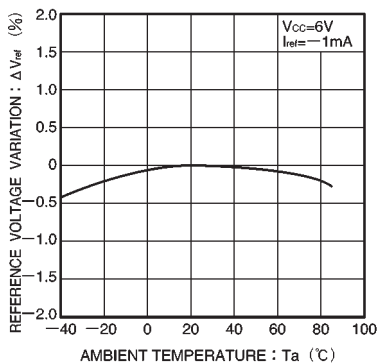

Fig.2 Reference voltage vs. ambient temperature

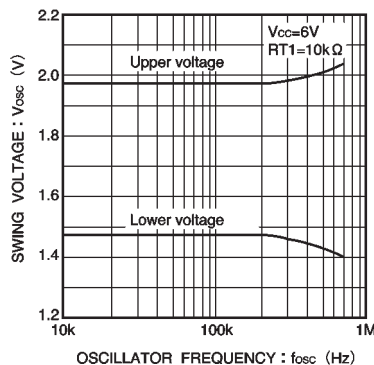

Fig.3 Swing voltage vs. frequency

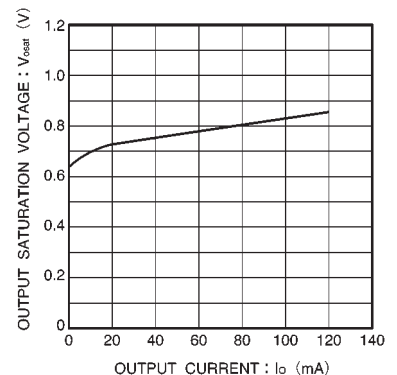

Fig.4 Output current vs. output saturation voltage

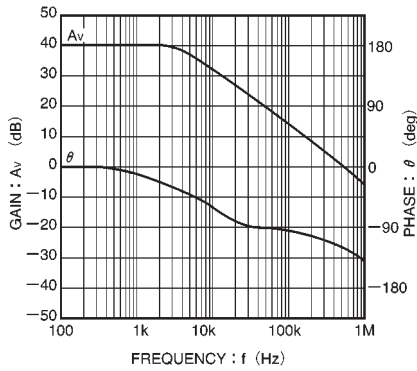
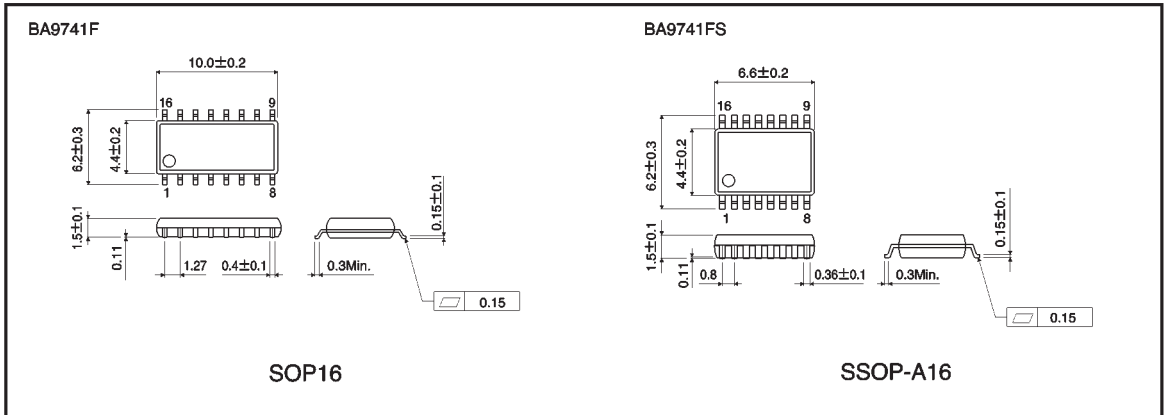

Fig.5 Error amplifier AC gain characteristic (40dB close)

● External dimensions (Units: mm)



This datasheet has been download from:

www.datasheetcatalog.com

Datasheets for electronics components.